

How do

[contact us](#)

Indigo Buntings locate the same acre of land every summer?

They **calculate** their position using the stars.

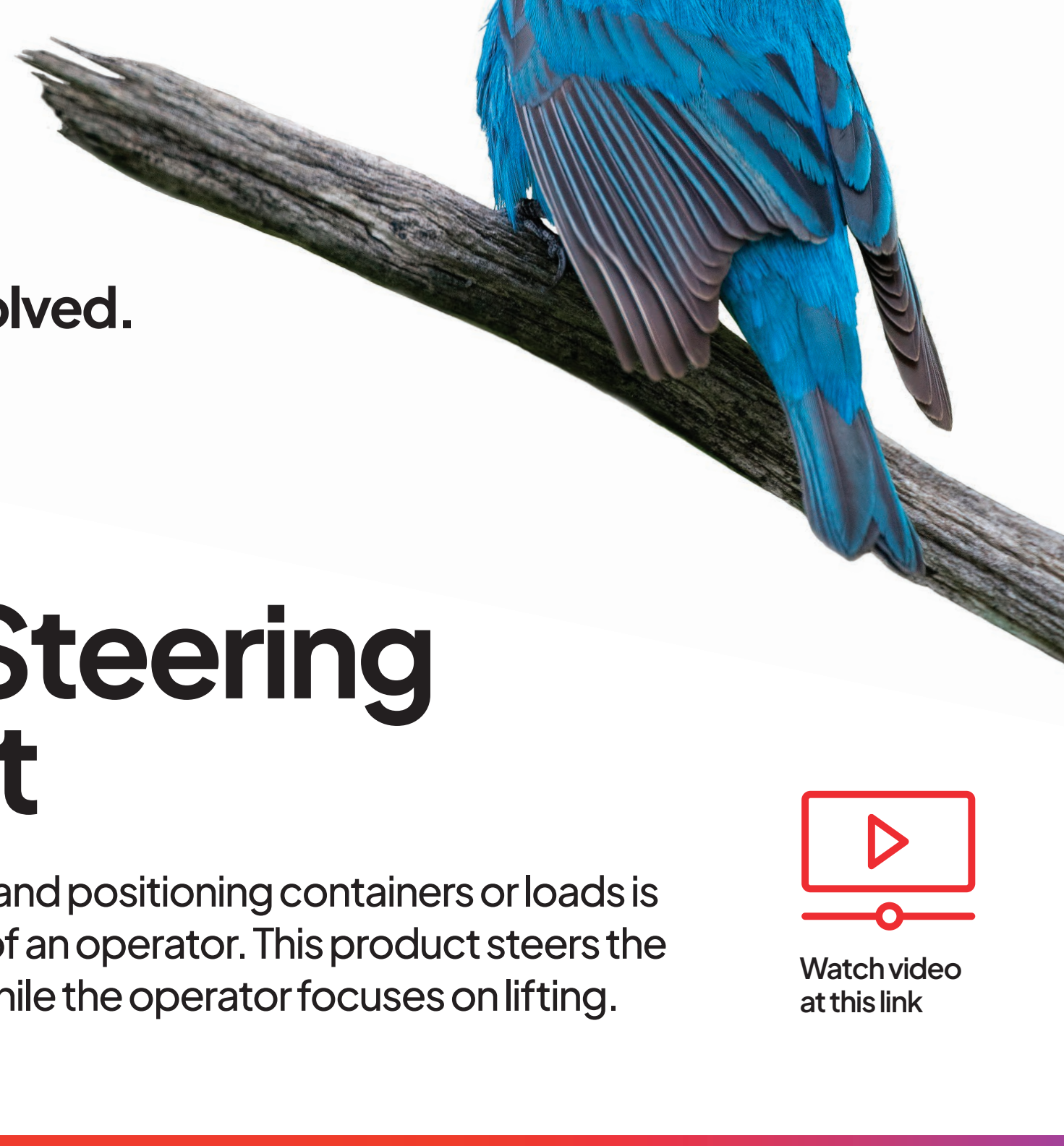

Positioning. Evolved.

Auto-Steering Retrofit

Safely lifting, moving and positioning containers or loads is the primary function of an operator. This product steers the crane into position, while the operator focuses on lifting.

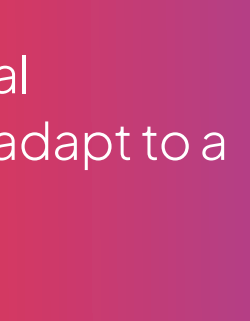

Adapt and thrive

Konecranes is the premier port services provider to brownfield terminal developments. Our range of retrofit products will enable your fleet to adapt to a fast-changing environment. Welcome to your evolution.

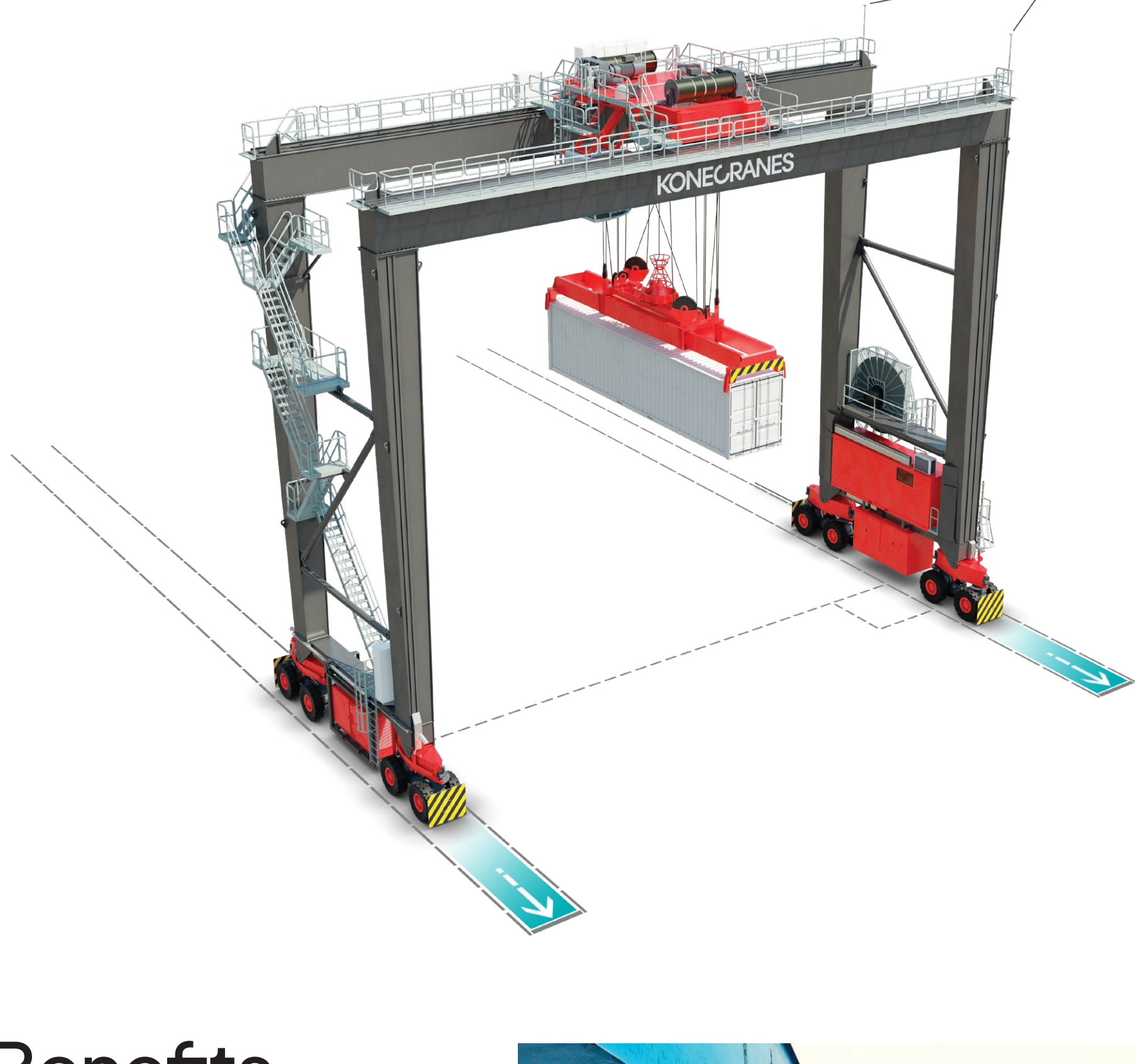

Benefits

- Prevent collisions caused by loose configurations
- Operator is focused only on accurate lifting and placement
- Prepares crane for further automation features
- Can initiate traverse turns in railyards
- More precisely optimized stack alignment for greater stack density
- Accurate, real-time heading at all times
- Option for additional reefer collision prevention.

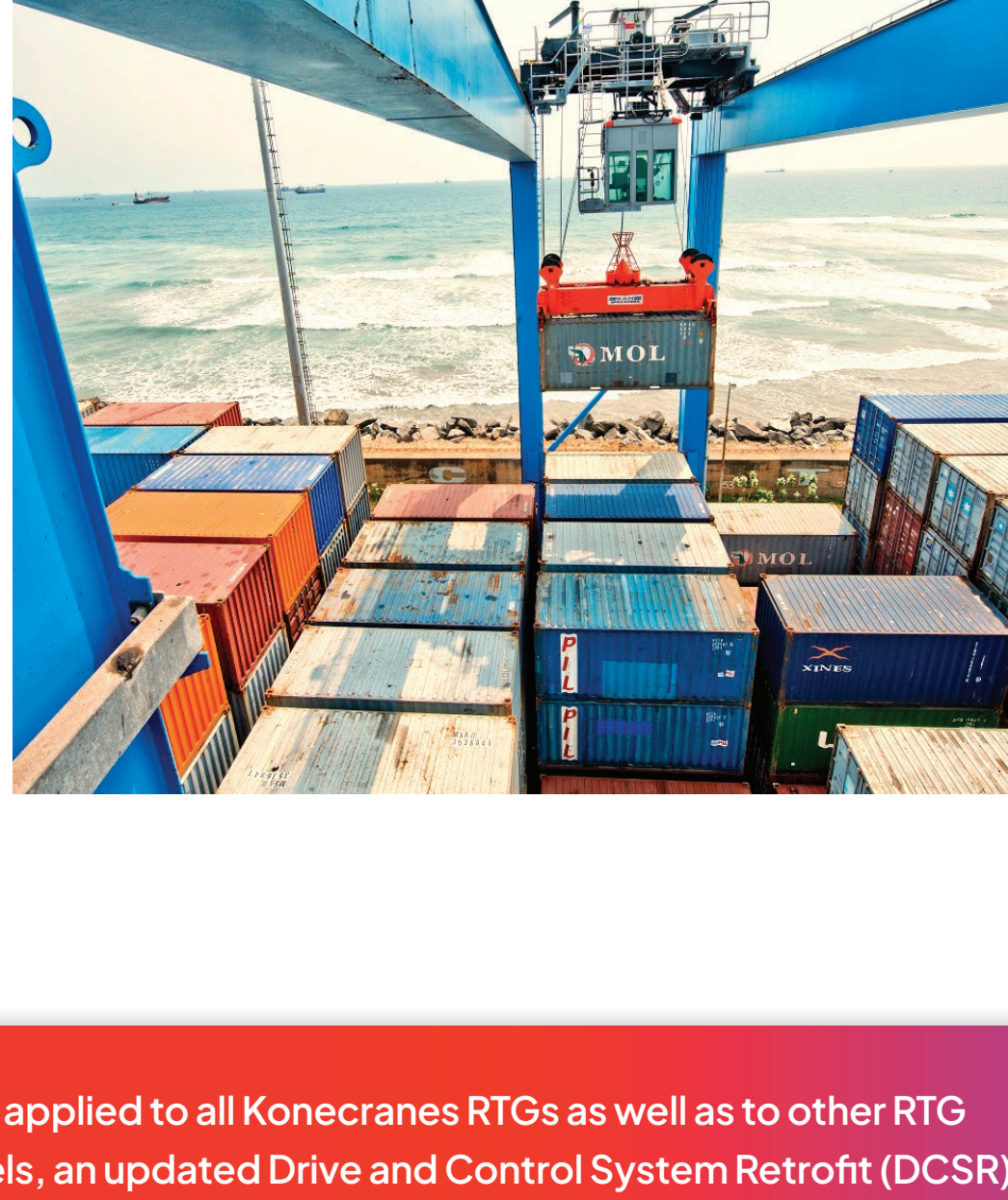

AB
Any Brand

This technology can be applied to all Konecranes RTGs as well as to other RTG brands. For older models, an updated Drive and Control System Retrofit (DCSR) is required.

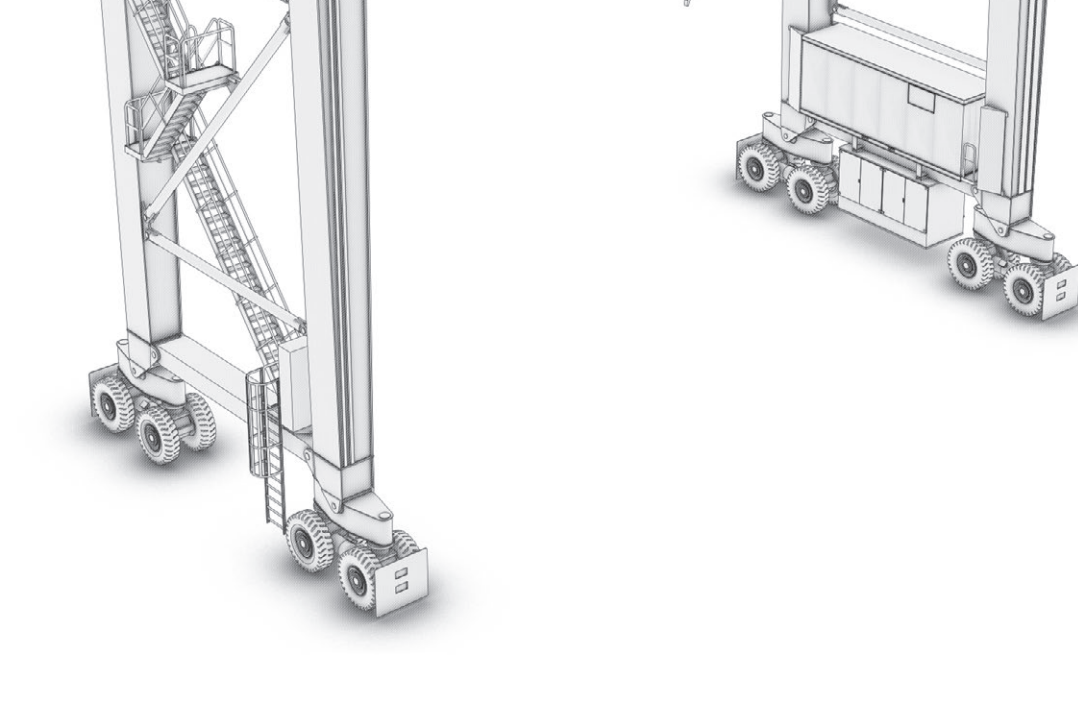

RTG
Rubber-Tired Gantry Crane

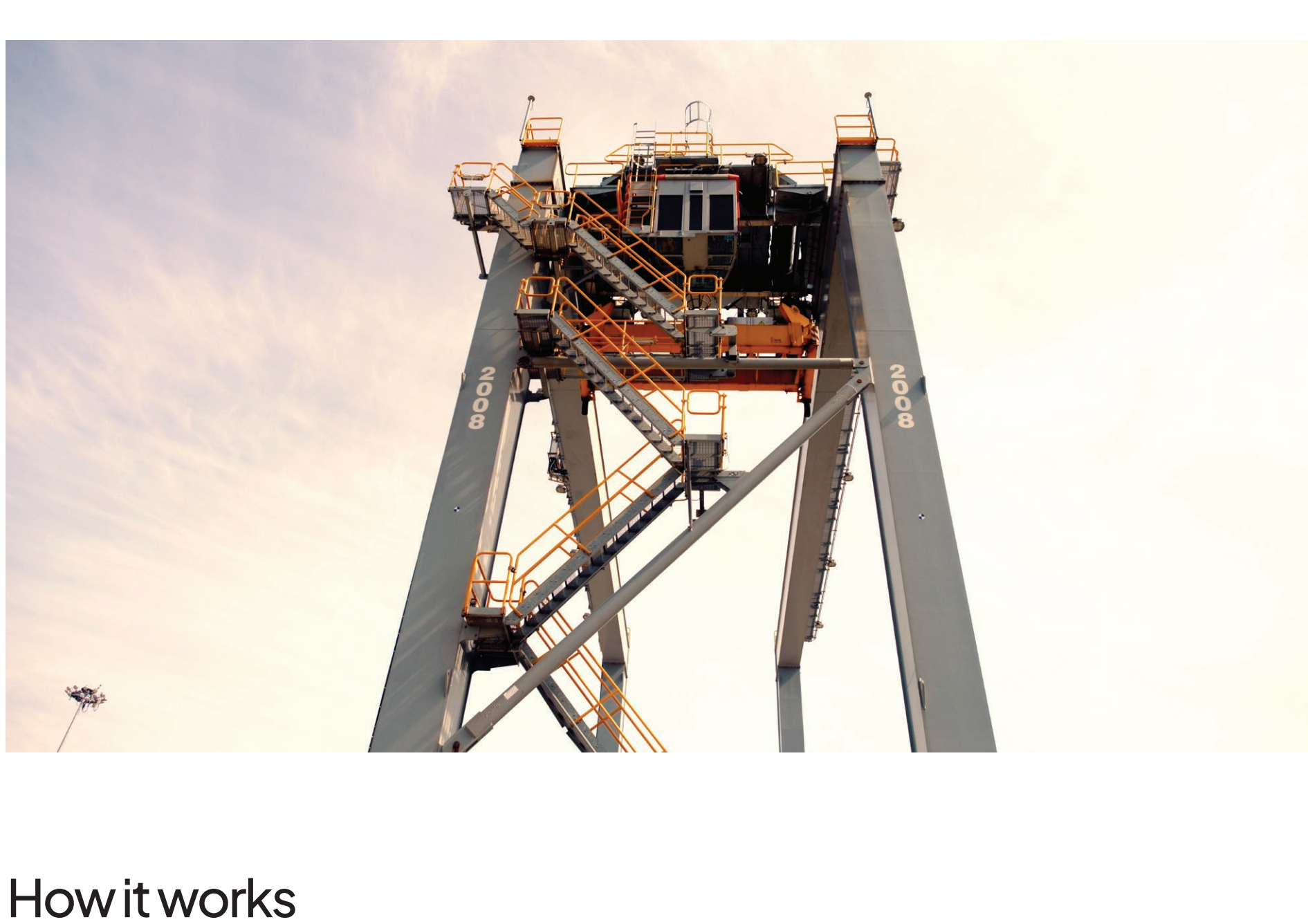

How it works

- GPS base station is installed in the terminal, the crane then uses radio frequency to communicate its real-time GPS position
- RTG drive lanes are pre-programmed into the memory
- Slow down and stop areas can also be programmed
- Automatic slow-down/stop on any path deviation
- Programmable speed restrictions in areas such as reefer racks
- Can be augmented with laser scanner-based smart steering
- If WLAN is available, both radio and WLAN can be combined which boosts communication in places where radio interference is present.

What you need to know

- Auto-Steering is a prerequisite for Auto-TOS Reporting, Auto-Positioning, Auto-Path and Auto-Truck Guiding
- Customer needs:
 - To apply for necessary radio frequency license that the system needs for the base station communication
 - Site works and commissioning: 5 days for the first crane and 3 days for every crane thereafter
 - To name a location for the base station and install the cubicle, antenna and wiring. Konecranes builds the antenna connection
 - If WLAN is used, to provide a functional WLAN network with strong coverage in the whole area where the RTGs operate (optional)
- Konecranes will assist in providing the necessary information to complete these tasks
- Pre-programmed memory allows Konecranes to utilize only 1 base station for over 160 RTGs at the same time.



Selected References

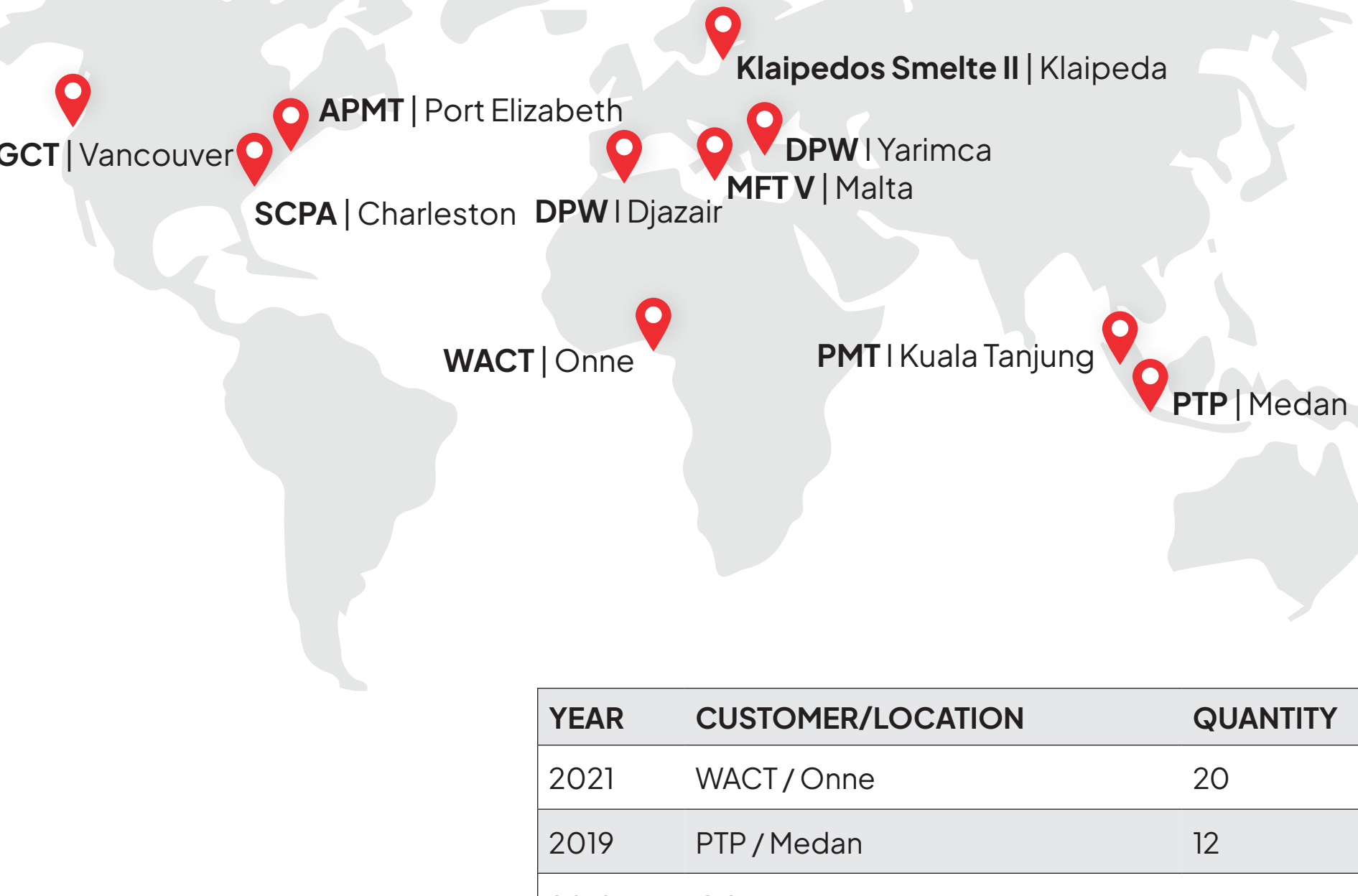

YEAR	CUSTOMER/LOCATION	QUANTITY
2021	WACT / Onne	20
2019	PTP / Medan	12
2019	GCT / Vancouver	6
2019/20	SCPA / Charleston	31
2019	MFT V / Malta	15
2019	DPW / Djazair	5
2018	APMT / New Jersey	20
2018	PMT / Kuala Tanjung	8
2015	DPW / Yarmica	18

Ports. Evolved.



Konecranes is a global leader in material handling solutions, serving a broad range of customers across multiple industries. We consistently set the industry benchmark, from everyday improvements to the breakthroughs at moments that matter most, because we know we can always find a safer, more productive and sustainable way. That's why, with around 16,600 professionals in over 50 countries, Konecranes is trusted every day to lift, handle and move what the world needs. In 2023, Group sales totalled EUR 4.0 billion. Konecranes shares are listed on Nasdaq Helsinki (symbol: KCR).

© 2024 Konecranes. All rights reserved. "Konecranes", "Moves what matters" and are either registered trademarks or trademarks of Konecranes.
This publication is for general informational purposes only. Konecranes reserves the right at any time, without notice, to alter or discontinue the products and/or specifications referenced herein. This publication creates no warranty on the part of Konecranes, express or implied, including but not limited to any implied warranty or merchantability or fitness for a particular purpose.